

- 3/4-16 Stud Input w/Nut
- BNC (Amphenol) Output

6X ϕ .41 [10] THRU
ON A 6.25 [159] BOLT CIRCLE

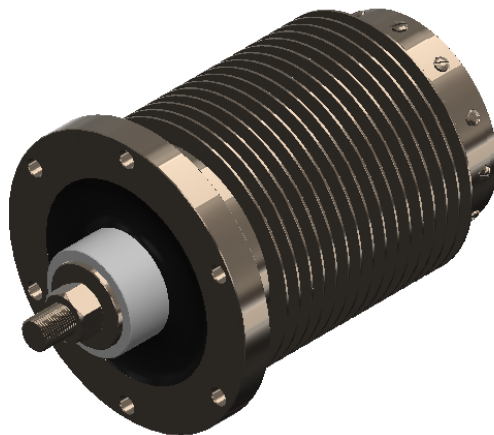

Specifications subject to change without notice.

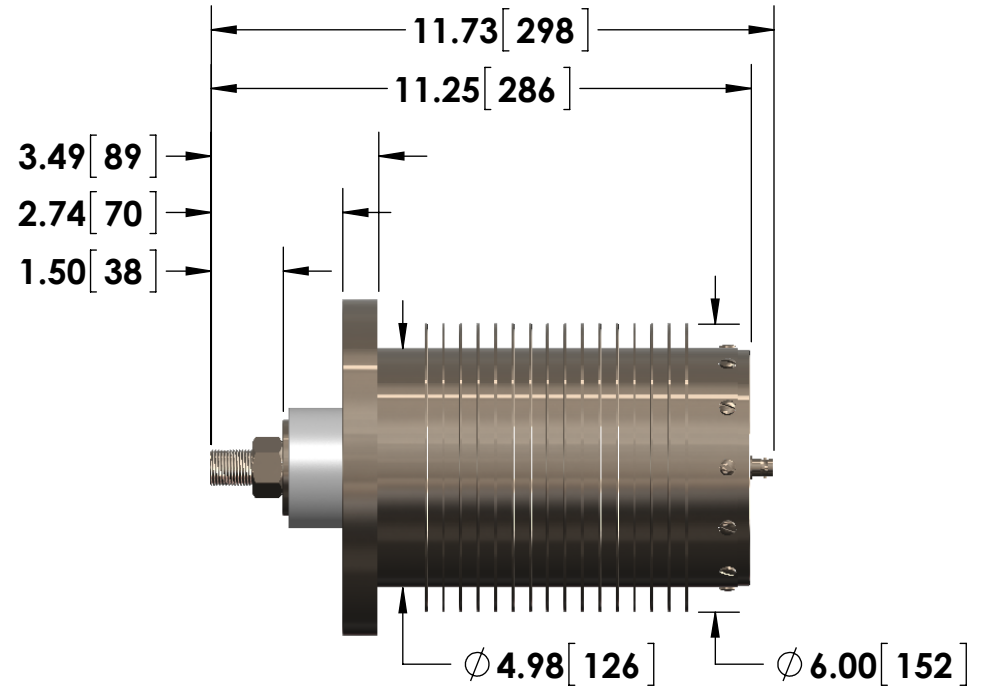
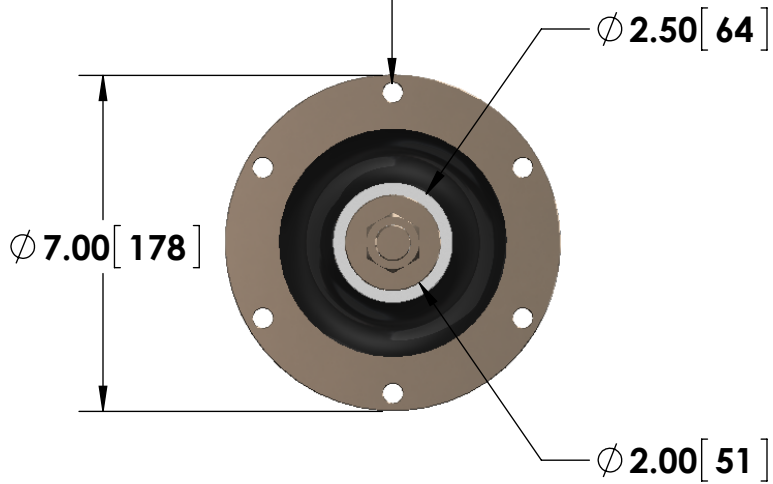

T & M RESEARCH PRODUCTS, INC.

TITLE: **R SERIES - 850 Watt Units**

DIMENSIONS: **inch[mm]**

DATE: **04-02-2015**